

140424 2 Zone Expander Panel

Installer Guide

For Use with Braeburn
Model 140404

Store this manual for future reference.



 **Warning** *Read all of the instructions before proceeding*

 **Caution** *Voltage Hazard*

Can cause electrical shock or equipment damage. Always turn off power to the heating/air conditioning system prior to installing or adjusting the Zone Panel Expander. Complete the wiring for the main panel and expansion panel before applying transformer power.

This panel is designed for professional installation, and is to be installed and configured as described in this manual. Any other use is not recommended and will void the warranty. Install disconnect and overload protection on circuits as required by code authorities having jurisdiction for the installation.

Table of Contents

- 1** Specifications.....2
- 2** Suitable Mounting Locations.....3
- 3** Wiring Diagrams..... 5-9
- 4** Zone Addressing.....9
- 5** Adding Zones to Main Panel.....10
- 6** Operation.....10
- 7** Error Conditions.....11
- 8** Warranty.....12

1 Specifications

Storage temperature:
-40°–167°F (-40°–75°C)

Operating temperature:
-22°–167°F (-30°–75°C)

Voltage:
24 VAC, Nominal 60Hz
18-30 VAC Maximum

Operating humidity:
5–95% RH

Panel Power:
4 VA @ 24 VAC

Current Draw Max:
75 VA @ 24 VAC

Current Draw Per Zone:
50 VA Max

Protection:
Electronic self resetting current limiting for panel power and damper zones

Configuration:
Zone number by switch setting

Maximum Zones:
2 Zones Per Expander Panel
Up to a Maximum of 14 Two Zone Expanders = 32 Total Zones (28 Expander Zones, 4 Main Panel Zones)

Dimensions:
See Figure 1

Figure 1

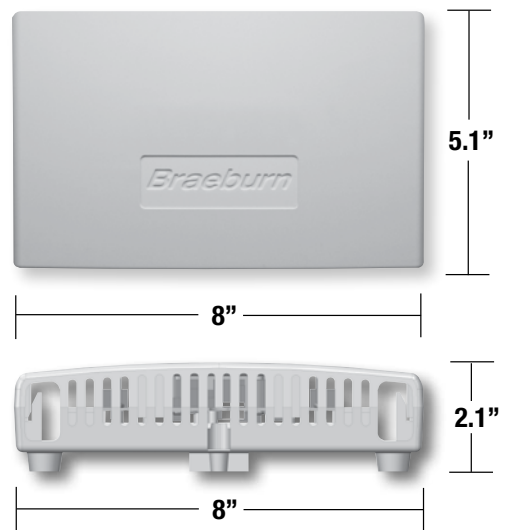

2 Suitable Mounting Locations

Mount the Zone Panel Expander near the Main Panel. If desired, the expander panel can be mounted up to 500 feet from the main panel. The panel can be mounted in any orientation on a wall, stud, roof truss, or the return-air plenum. For appearance, mount the panel near the main panel for easy panel to panel wiring. Remove the panel cover and use the base as a template to drill mounting holes (see Figure 2). Attach the panel with appropriate screws. Use mounting anchors as needed for drywall or plaster installations.

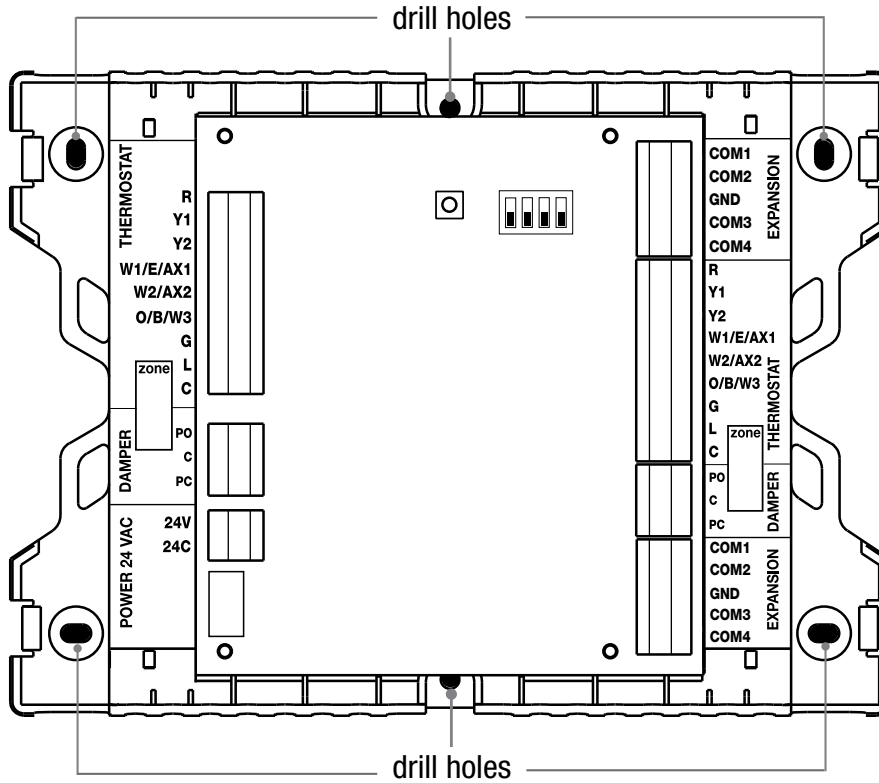

Figure 2

3 Wiring the Panel

Always turn off power to the heating/air conditioning system prior to installing or adjusting the Zone Panel Expander. Use the following general wiring instructions for all systems. Specific wiring will vary depending on the type of thermostats and dampers used for the installation. **NOTE:** Up to 2 wires can be inserted into each terminal position. To release wires, press down on top of wiring terminal and gently pull out wire(s).

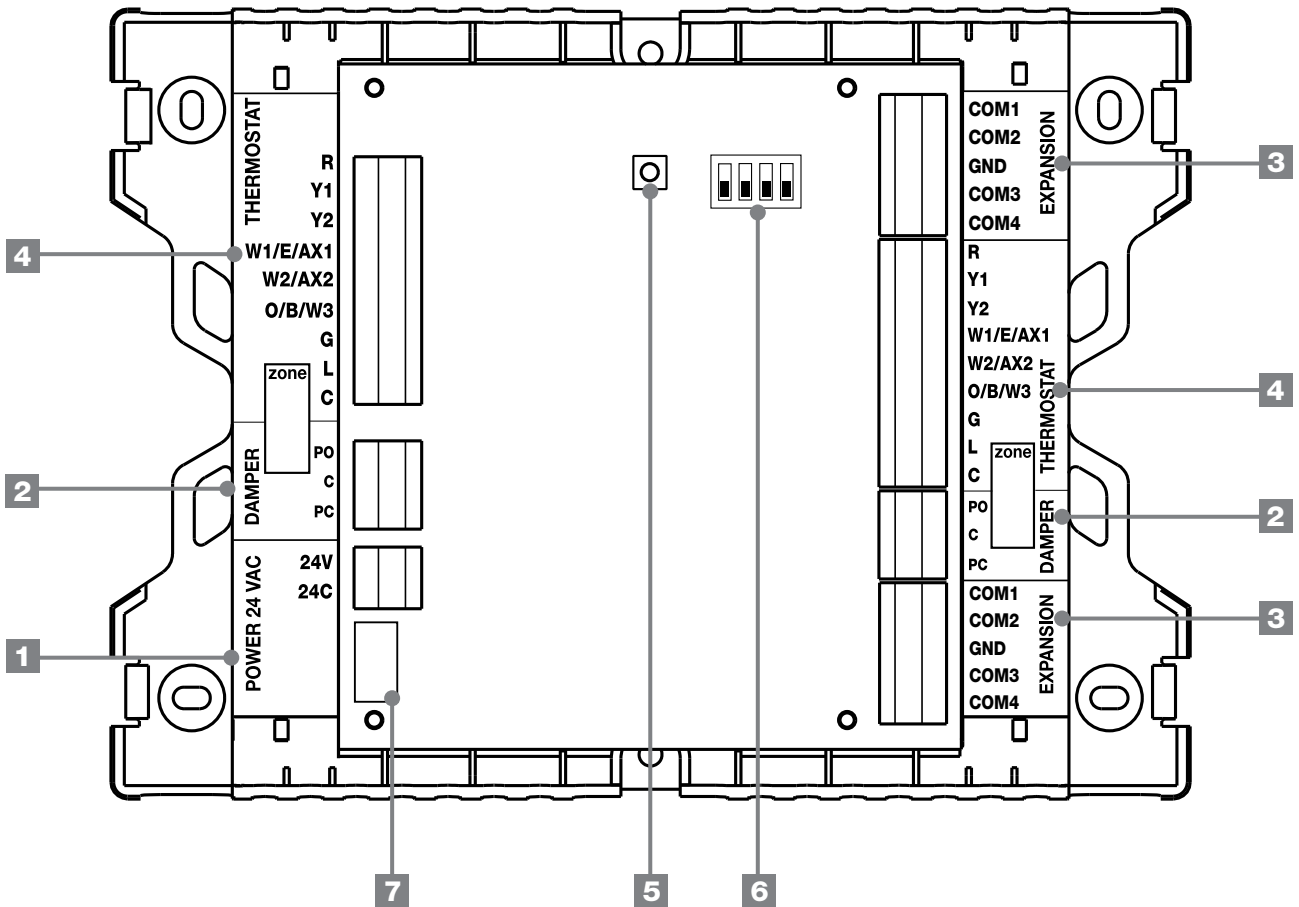

Figure 3

ZONE PANEL EXPANDER WIRING TERMINALS

	Terminal	Qty.	Function	Description
PANEL POWER	24V	1	INPUT	24 VAC Transformer Power 75 VA Maximum
	24C	1	INPUT	24 VAC Transformer Common
DAMPERS	PO	2	OUTPUT	24 VAC Power Open Zone Damper Terminal
	C	2	OUTPUT	Zone Damper Common Terminal
	PC	2	OUTPUT	24 VAC Power Close Zone Damper Terminal
EXPANSION	COM1	2	OUTPUT	Expander Panel Communication
	COM2	2	OUTPUT	Expander Panel Communication
	GND	2	INPUT	Expander Panel Communication Ground
	COM3	2	INPUT	Expander Panel Communication
	COM4	2	INPUT	Expander Panel Communication
THERMOSTAT	R	2	OUTPUT	24 VAC Thermostat Power
	Y1	2	INPUT	1st Stage Compressor Call
	Y2	2	INPUT	2nd Stage Compressor Call
	W1/E/AX1	2	INPUT	[W1] 1st Stage Conventional Heat Call [E] Emergency Heat Call [AX1] 1st Stage Auxiliary Heat Call
	W2/AX2	2	INPUT	[W2] 2nd Stage Conventional Heat Call [AX2] 2nd Stage Auxiliary Heat Call
	O/B/W3	2	INPUT	[O] Cool Active Reversing Valve Call [B] Heat Active Reversing Valve Call [W3] 3rd Stage Conventional Heat Call
	G	2	INPUT	Fan Call
	L	2	OUTPUT	System Malfunction Indicator
C	2	OUTPUT	24 VAC Transformer Common	
5	RESET BUTTON			Press once to restart panel Hold for 5 seconds to reset panel and reset all factory defaults.
6	ZONE ADDRESS DIP SWITCHES			See Zone Addressing (section 4)
7	WIRE STRIP GUIDE			Wires should be stripped 3/8 inch minimum.

The expansion zones may be wired to either the top or bottom communication terminals on the main panel or to the top or bottom communication terminals on the expansion panel. This wiring flexibility allows the installer to choose the most flexible, cost effective wiring for the installation.

Each expansion panel must have a 5 Wire connection for proper communication. It is not necessary to use shielded wire for the panel to panel connection. 18 - 20 Gauge solid thermostat wire or similar is acceptable. When wiring the expansion panels be sure to connect the terminals from one panel to the next using the following terminal connections.

MAIN Panel to Expander

Main Panel	to	Expansion Panel
COM1	→	COM1
COM2	→	COM2
GND	→	GND
COM3	→	COM3
COM4	→	COM4

Expander to Expander

Expansion Panel	to	Expansion Panel
COM1	→	COM1
COM2	→	COM2
GND	→	GND
COM3	→	COM3
COM4	→	COM4

Example Wiring Options

Daisy Chain All Zones Located at Main Panel

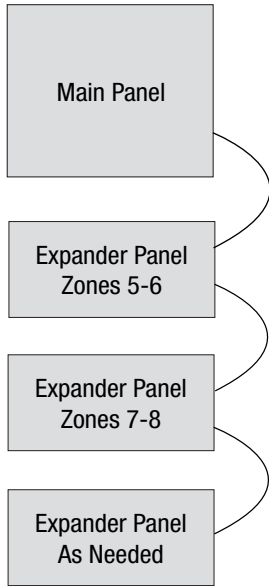

Star Wiring All Zones Located at Main Panel

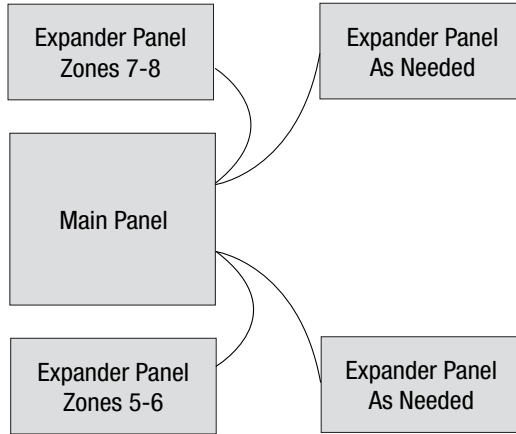

Daisy Chain Zones Located Remote to Main Panel (Up to 500 Feet)

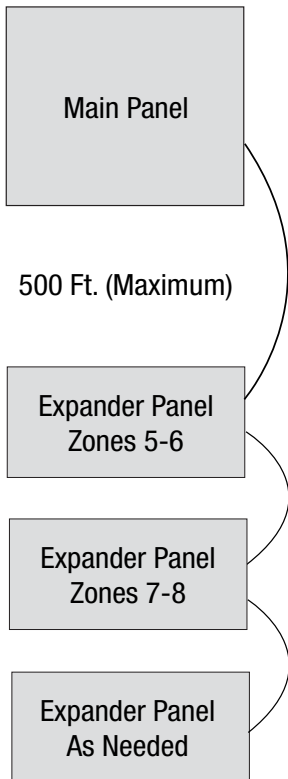

Daisy Chain Zones Located Remote to Main Panel - Remote Panels Wired in Star Configuration

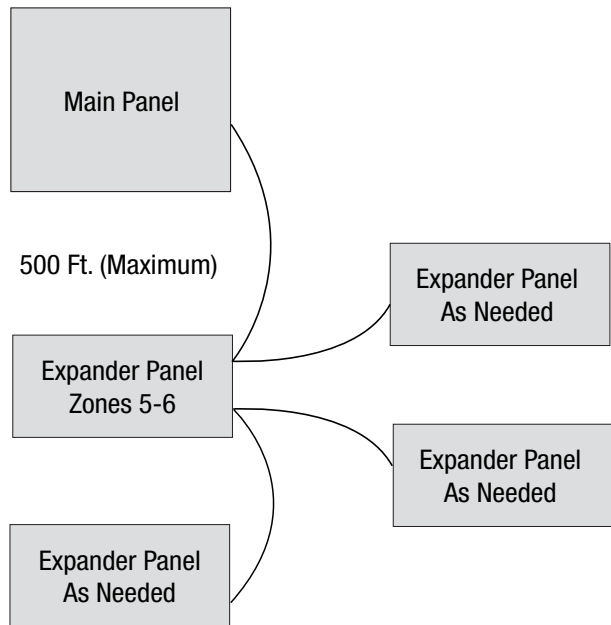

NOTE: To prevent possible interference do not run low voltage wiring along side 120 VAC wiring or magnetic ballasts.

3.1 Damper Wiring

Install the system dampers using the instructions provided by the manufacturer. Connect the dampers to the zone panel expander as shown for either a 2-wire or 3-wire damper. The sum of all dampers powered by the zone panel should not exceed 75 VA at 24 VAC. Use a slave relay if additional damper power is required.

ALWAYS PROVIDE DISCONNECT AND OVERLOAD PROTECTION AS REQUIRED

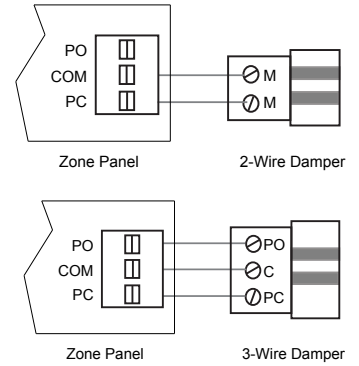

3.2 Thermostat Wiring

CONVENTIONAL THERMOSTATS

1 HEAT / 1 COOL

R	24 VAC Power
W1	Heat Call
Y1	Cooling Call
G	Fan Call
C	24 VAC Transformer Common [Note 1]

2 HEAT / 2 COOL

R	24 VAC Power
W1	Heat Call Stage 1
W2	Heat Call Stage 2
Y1	Cooling Call Stage 1
Y2	Cooling Call Stage 2
G	Fan Call
C	24 VAC Transformer Common [Note 1]

3 HEAT / 2 COOL

R	24 VAC Power
W1	Heat Call Stage 1
W2	Heat Call Stage 2
W3	Heat Call Stage 3
Y1	Cooling Call Stage 1
Y2	Cooling Call Stage 2
G	Fan Call
C	24 VAC Transformer Common [Note 1]

NOTES

[1] Wiring to the C terminal is required only for thermostat power.

HEAT PUMP THERMOSTATS

1 HEAT / 1 COOL - No Auxiliary Heat

R	24 VAC Power
O/B	Changeover Valve [Note 2]
Y1	Compressor Call (1st Stage Heating/Cooling)
G	Fan Call
C	24 VAC Transformer Common [Note 1]

2 HEAT / 2 COOL - No Auxiliary Heat

R	24 VAC Power
O/B	Changeover Valve [Note 2]
L	Optional System Fault Monitor
Y1	Compressor Call Stage 1 (1st Stage Heating/Cooling)
Y2	Compressor Call Stage 2 (2nd Stage Heating/Cooling)
G	Fan Call
C	24 VAC Transformer Common [Note 1]

2 HEAT / 1 COOL - With Auxiliary Heat

R	24 VAC Power
O/B	Changeover Valve [Note 2]
L	Optional System Fault Monitor
W2	Auxiliary Heat Relay (2nd Stage Heating)
Y1	Compressor Call (1st Stage Heating/Cooling)
E	Emergency Heat Call
G	Fan Call
C	24 VAC Transformer Common [Note 1]

3 HEAT / 2 COOL - With Auxiliary Heat

R	24 VAC Power
O/B	Changeover Valve [Note 2]
L	Optional System Fault Monitor
AX1	Auxiliary Heat Relay (3rd Stage Heating)
Y1	Compressor Call (1st Stage Heating/Cooling)
Y2	Compressor Call (2nd Stage Heating/Cooling)
E	Emergency Heat Call
G	Fan Call
C	24 VAC Transformer Common [Note 1]

4 HEAT / 2 COOL - With Auxiliary Heat

R	24 VAC Power
O/B	Changeover Valve [Note 2]
L	Optional System Fault Monitor
AX1	Auxiliary Heat Relay (3rd Stage Heating)
AX2	Auxiliary Heat Relay (4th Stage Heating)
Y1	Compressor Call (1st Stage Heating/Cooling)
Y2	Compressor Call (2nd Stage Heating/Cooling)
E	Emergency Heat Call
G	Fan Call
C	24 VAC Transformer Common [Note 1]

NOTES

- [1]** Wiring to the C terminal is required only for thermostat power.
[2] O (Cool active) or B (Heat active) must match the zone panel installer settings.

3.3 Transformer Wiring

Install the transformer using the instructions provided by the manufacturer. Size the transformer to the damper requirements. The zone panel has a built-in, self-resetting fuse. The maximum damper power per zone is 75 VA at 24 VAC. Connect the transformer to the zone panel as shown. **NOTE:** *Additional dampers or dampers with a higher current draw will require the use of a separate slave relay.* ALWAYS PROVIDE DISCONNECT AND OVERLOAD PROTECTION AS REQUIRED

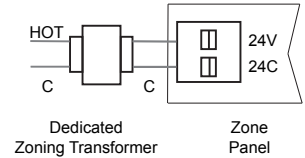

4 Zone Addressing

Use the following instructions to identify the zones on the zone panel expander. No other configuration is necessary on the zone panel expander. Carefully slide the dip switches to match the new zone numbers.

Use the open area provided on the expander panel to mark the new zone numbers. When setting the switches to identify the expander panel, use a pen or small screwdriver. Do not use a pencil, which may contain conductive material in the writing point.

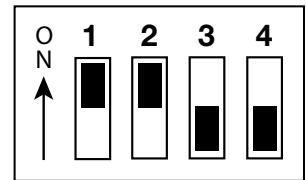

Example Switch Position for Zones 15 and 16

Switch Position

Zone ID	1	2	3	4
5 and 6	OFF	OFF	OFF	OFF
7 and 8	ON	OFF	OFF	OFF
9 and 10	OFF	ON	OFF	OFF
11 and 12	OFF	OFF	ON	OFF
13 and 14	OFF	OFF	OFF	ON
15 and 16	ON	ON	OFF	OFF
17 and 18	ON	OFF	ON	OFF
19 and 20	ON	OFF	OFF	ON
21 and 22	OFF	ON	ON	OFF
23 and 24	OFF	ON	OFF	ON
25 and 26	OFF	OFF	ON	ON
27 and 28	ON	ON	OFF	OFF
29 and 30	ON	ON	OFF	ON
31 and 32	ON	OFF	ON	ON

5 Add Zones to Main Panel

The 4 Zone Expandable Panel can be expanded to up to 32 zones with four zones on the main panel and 28 total expansion zones. Additional zones must have power and communication wires to be recognized and controlled by the main expandable panel. To add additional zones, complete all wiring and start the main panel test mode.

Start the panel test mode to add additional zones:

1. Ensure all wiring is complete, zone addresses are set (section 4), and power has been applied to the main and expansion panels.
2. Press **TEST** for 3 seconds and release.
3. Press and release **SELECT** once for each new zone added.
New zones must be added in blocks of two. **NOTE:** After second new zone is added, expander LED will change from red to green, and ZONE OK will appear in the main panel display.
4. If new zones do not appear, check wiring and ensure expansion zones have power.
5. Press **HOLD FOR EXIT** for 3 seconds to complete adding zones.

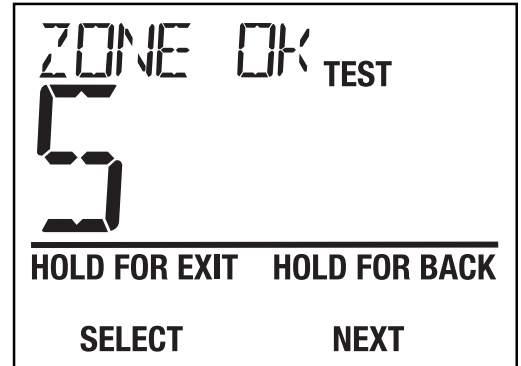

6 Operation

The Zone Panel Expander has built in LED's to tell the installer and the system owner the current operating mode of the panel. Refer to the figure below and the following descriptions of the panel LED's for operation information.

LED	COLOR	INDICATION
Panel Status LED		
Panel Power	Red Green	Flashing Red until communication is good Flashing Green when in normal operation
Thermostat LED's (2 Positions)		
R	Red	24 VAC available to Thermostat
Y1	Yellow	Thermostat First Stage Compressor Call
Y2	Yellow	Thermostat Second Stage Compressor Call
W1/E/AX1	White	Thermostat Call for W1 or E or AX1
W2/AX2	White	Thermostat Call for W2 or AX2
O/B/W3	Yellow	Thermostat Call for O, B or W3
G	Green	Thermostat Fan Call
L	Yellow	System Check Signal to Thermostat Active
Damper LED's (2 Positions)		
Power Close / Power Open	Red / Green	Red On Damper Closed; Green on Damper Open No light when wiring short detected.

7 Error Conditions

The following messages will be displayed on the Main Panel if incorrectly addressed expansion panels are detected during expander configuration when the Main Panel is in the TEST mode.

Invalid Address on Expansion Panel

Displayed when an invalid address has been set on an expansion panel. This message will appear when an expander is powered up and wired to the communication terminals. To locate the expander panel with the invalid address, view the expander panel status LED. The status LED will be flashing red.

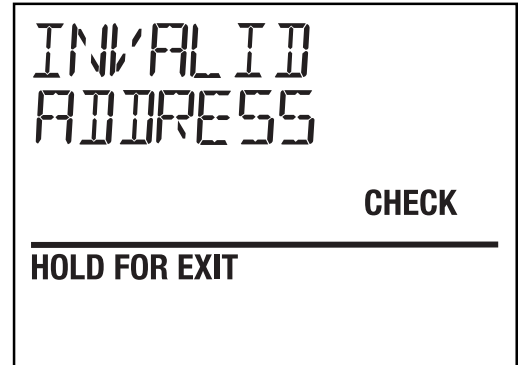

Duplicate Address on Expansion Panel

Displayed when a duplicate address has been set on an expansion panel. This message will appear when an expander is powered up and wired to the communication terminals. To locate the expander panel with the duplicate, view the expander panel status LED. The status LED will be flashing red. Change the expander switches as noted in section 4 to remove duplicate addresses.

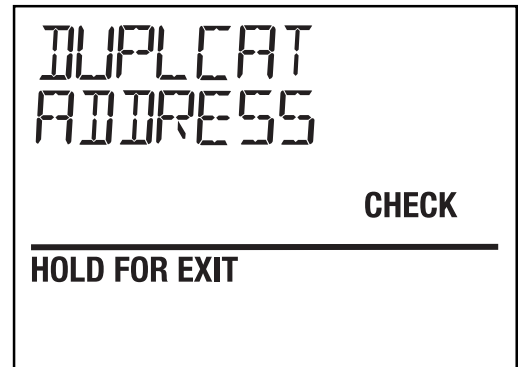

The Main Panel continually monitors the status of the expansion panel(s) and will display the following message if communication is lost with a previously connected expander panel.

Communication Lost with Expansion Panel

This message is displayed if the Main Panel loses communication with an expansion panel. Check the wiring between the Main Panel and the expansion panel, and confirm that the addressing dip switches are configured properly.

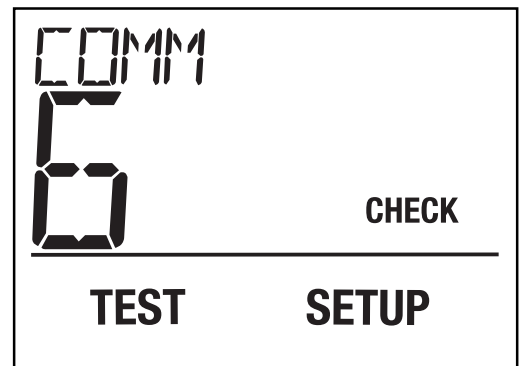

Limited Warranty

When installed by a professional contractor, this product is backed by a 5 year limited warranty. Limitations apply. For limitations, terms and conditions, you may obtain a full copy of this warranty:

- Visit us online: www.braeburnonline.com/warranty
- Phone us: 866.268.5599
- Write us: Braeburn Systems LLC
2215 Cornell Avenue
Montgomery, IL 60538



Store this manual for future reference.

Braeburn®

Braeburn Systems LLC
2215 Cornell Avenue • Montgomery, IL 60538
Technical Assistance: www.braeburnonline.com
Call us toll-free: 866-268-5599 (U.S.)
630-844-1968 (Outside the U.S.)